

DTS-100/101/102

features

200A



- Digital Time Switch with:
Daily / Weekly / ***Astronomical Program
- *LCD Display with Backlight
- Holiday Mode
- Single / **Double Channel
- 5 or 10 Years Power Reserve (lithium battery)
- 40 Programs / **100 Programs
- Sealable Front Cover
- Single / Double Channel
- Manual Control by Keys Combination
- Automatic Transfer of Weekdays
- Double Module
- Din-rail Mount (TH-35 rail)

technical data

Model	DTS-100	DTS-101	DTS-102	DTS-200A
Supply terminals	L-N			
Rated voltage	AC220~240 ±10%	AC/DC 24~264V ±10%		
Rated frequency	50/60 Hz			
Power consumption	1W		2W	1W
Number of programs	40		100	40
Program	daily / weekly			+ Astronomical
Mode of work	manual , automatic , holiday			
Summer/winter time	OFF , automatic changes			
Time tolerance	≤1s/day at 25° C			
Power reserve	5 yrs	10 yrs		
Data readout	LCD display	LCD display with backlit		
Number of contacts	1 C/O		2 C/O	1 C/O
Current of contacts	16A/250V AC1			
Switching capacity	4000VA/AC1, 384W/DC			
Mechanical life	10 ⁶			
Electrical life	10 ⁵			
Rated insulation voltage	250V			
Protection degree	IP20			
Pollution degree	3			
Altitude	≤ 2000m			
Ambient temperature	-20° C ~ +55° C			
Permissible relative humidity	≤ 50% (40° C, without condensation)			
Storage temperature	-30° C ~ +70° C			
Wire size	1mm ² ~ 4mm ²			
Tightening torque	0,5 Nm			
Mounting	TH-35 Rail (EN60715)			
Weight	approx. 210 g			
Enclosure Protection	IP20			
Standard	EN 60730-1/ EN 60730-2-7			

(*) DTS-101/102 (**) DTS-102 (***) DTS-200A

*Specification subject to change without prior notification (please visit www.delab.com.my for latest specification)

panel description

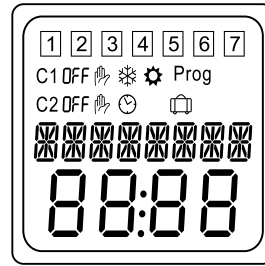
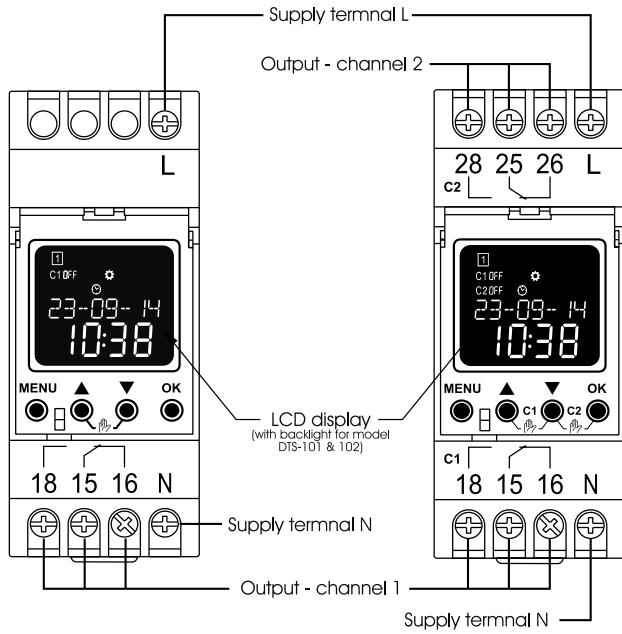

1 2 3 4 5 6 7

Days of the week
Monday, Tuesday....Sunday

C1 Channel 1

C2 Channel 2 (for model DTS-102)

OFF Activate

OFF Deactivate

⌚ Automatic mode

👉 Manual mode

🏠 Holiday mode

❄️ Winter mode

⚙️ Summer mode

Prog Program setting

wiring diagram

DTS-100 / 101

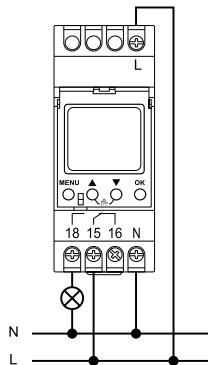
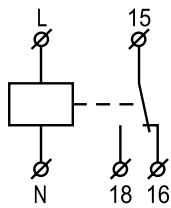

DTS-102

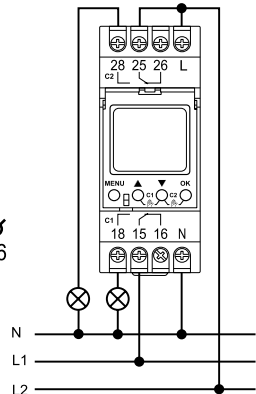
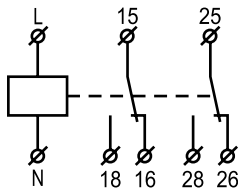

casing dimension

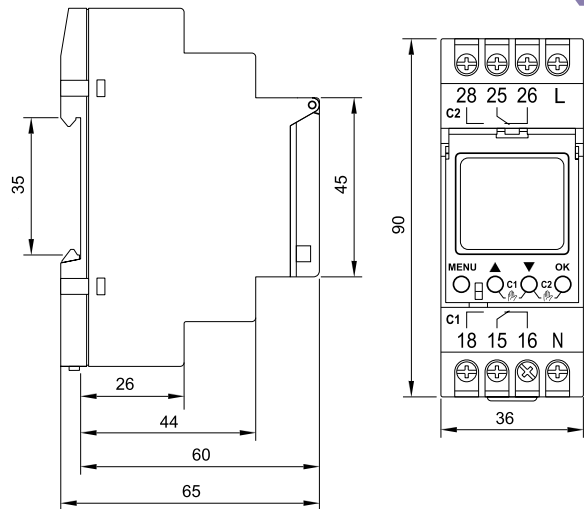

ordering information

Model	Description
DTS-100	220~240 Vac
DTS-101	24~264 Vac / dc
DTS-102	24~264 Vac / dc
DTS-200A	24~264 Vac / dc

Note: All measurement in mm.